



Love Birds

Lovebird is the name given to species of parrot that display deep loving feelings and look after their mates. They form very strong relationships with members of their flock, which is why they are named so. They are also very friendly to humans who display loving care towards them. This paper craft is of a pair of rosy-faced lovebirds, one of the most common species of lovebird, sitting nicely together on a tree branch.

Assembly Instructions

- 1) Carefully cut out the parts.
- 2) Make mountain folds and valley folds along the dotted lines, as indicated by the directions.
- 3) Attach the parts in order.
(Read the assembly instruction for more information.)
- 4) Your Paper craft model is finished.









Tools

Scissors, glue (We recommend a strong adhesive such as woodwork glue.)

Caution

Keep glue and scissors away from small children.
Be careful not to cut your fingers when using scissors.

Notation Key

	—————	Scissors line
	—————	Cut in line
	—————	Glue up to this line
	- - - - -	Mountain fold
	- - - - -	Valley fold
		Cut out
		Glue spot

Assemble 1 and 2 and attach them together to make the head.

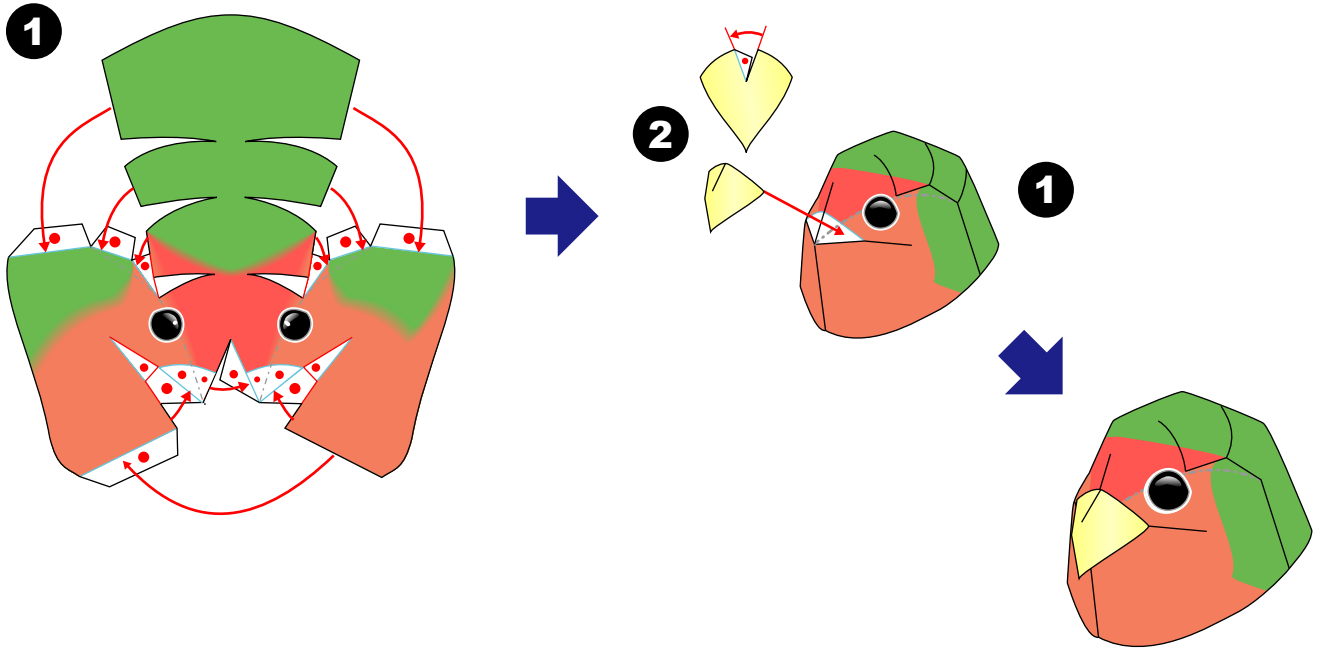

Assemble and glue 3 and 4.

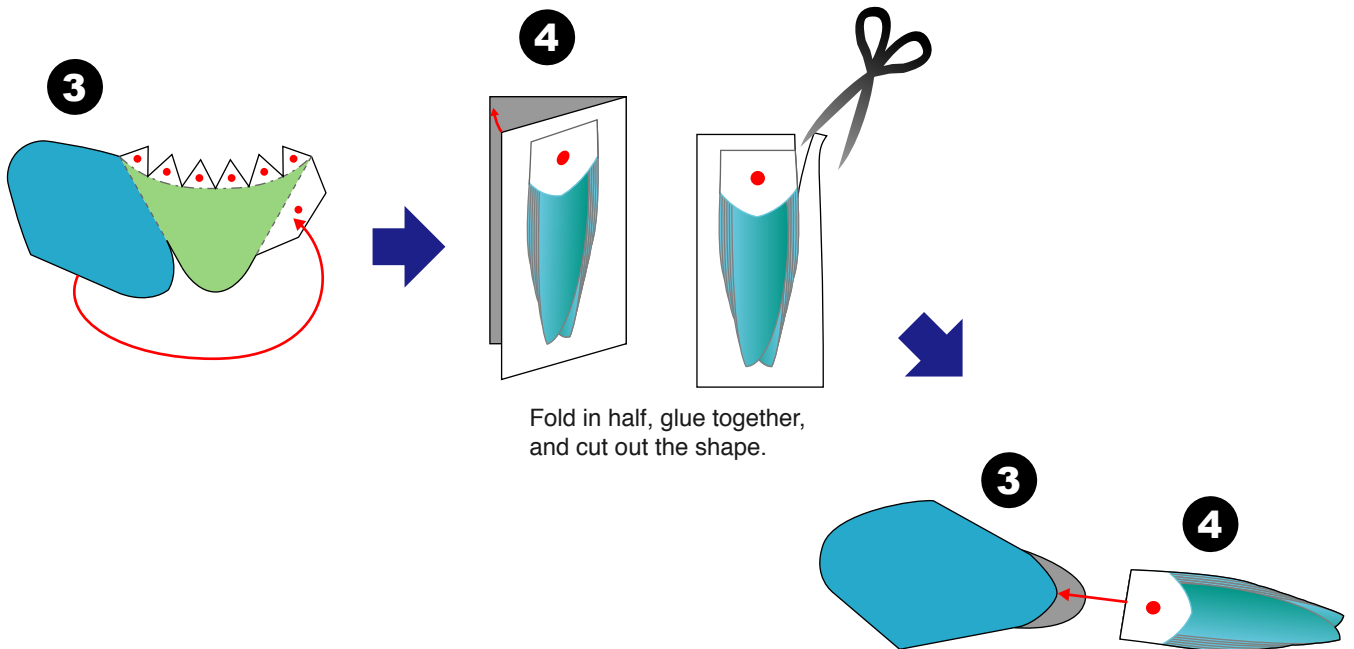

Assemble **5** and glue it to **3** and **4**.

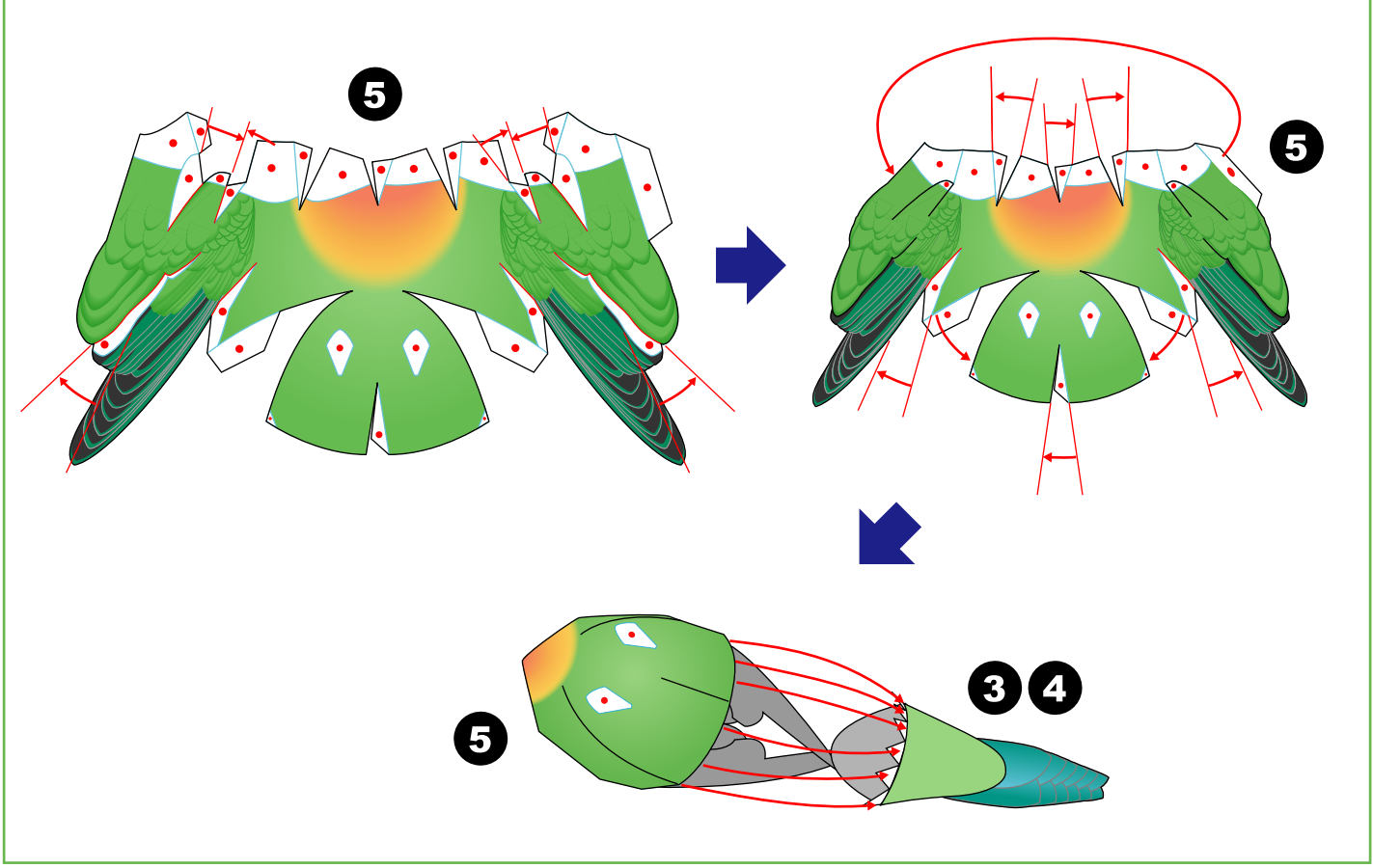

Assemble **6** and **7**. Next, glue **6**, **7**, and the head to **5** to complete the bird body.

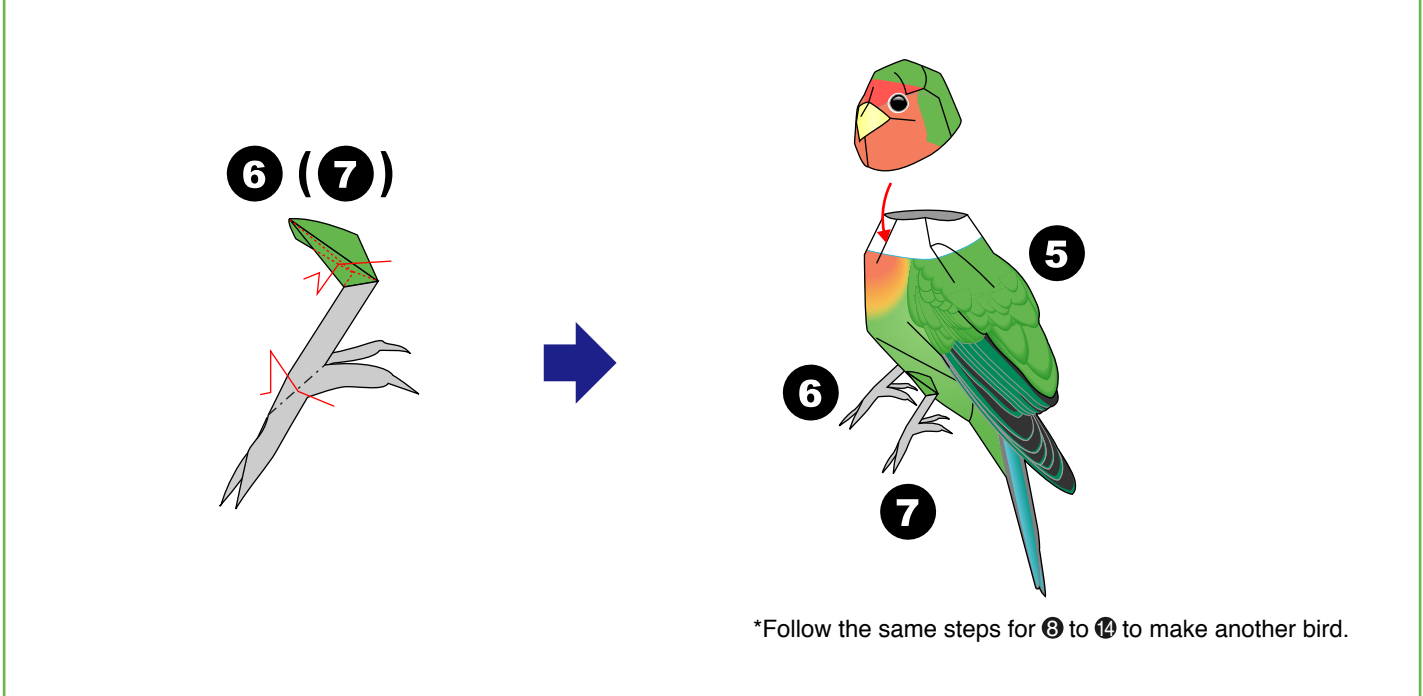

*Follow the same steps for **8** to **14** to make another bird.

Assemble and attach 15, 16, and 17 to make the stand.

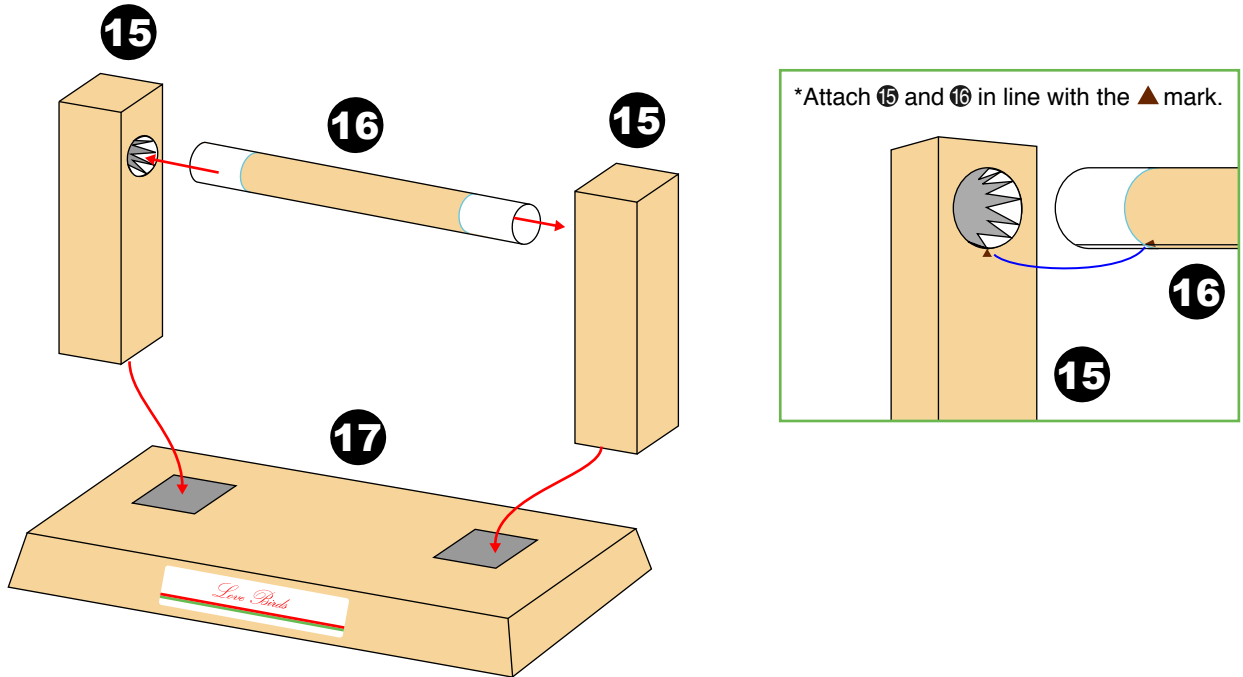

Attach the birds to the stand to complete the Love Birds.

